

**I-90/Massachusetts Turnpike
Between I-495, Hopkinton, and Route 1A, East Boston**

I-90/Mass Turnpike Eastbound: I-495, Hopkinton, to I-95/Route 128, Weston AWDT Traffic Flow Diagrams: 1977, 1987, 1997, and 2010

Route/Lane Schematic

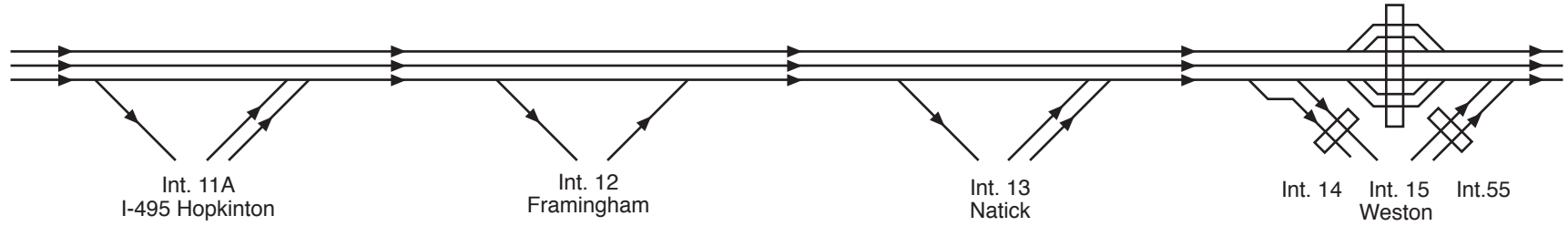

1977 AWDT

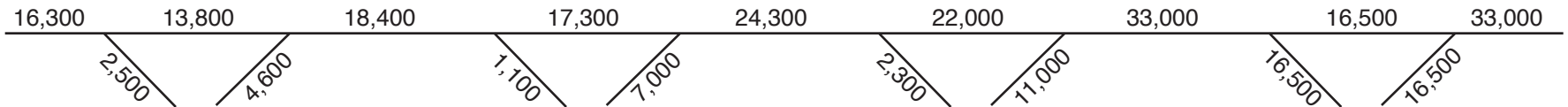

1987 AWDT

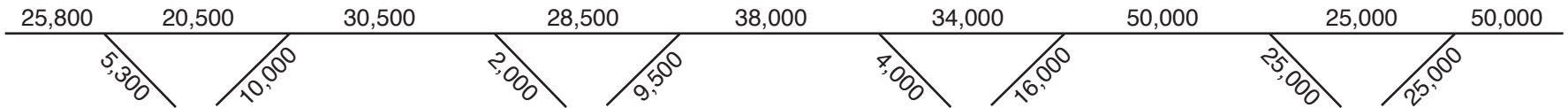

1997 AWDT

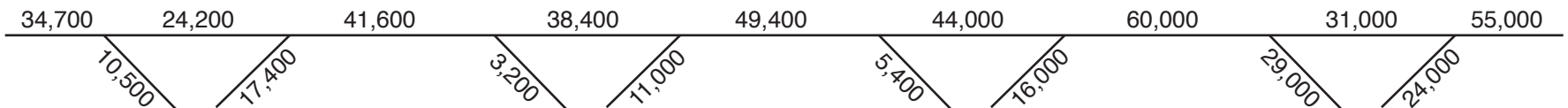

2010 AWDT

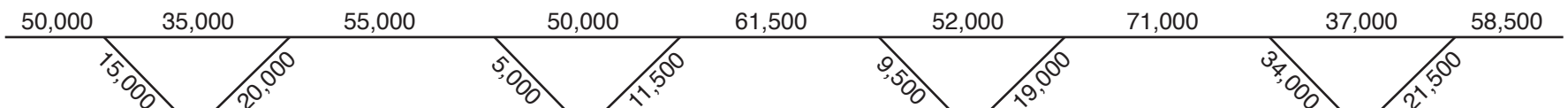

I-90/Mass Turnpike Eastbound: I-495, Hopkinton, to I-95/Route 128, Weston AM Peak Period Traffic Flow Diagrams: 2010

Route/Lane Schematic

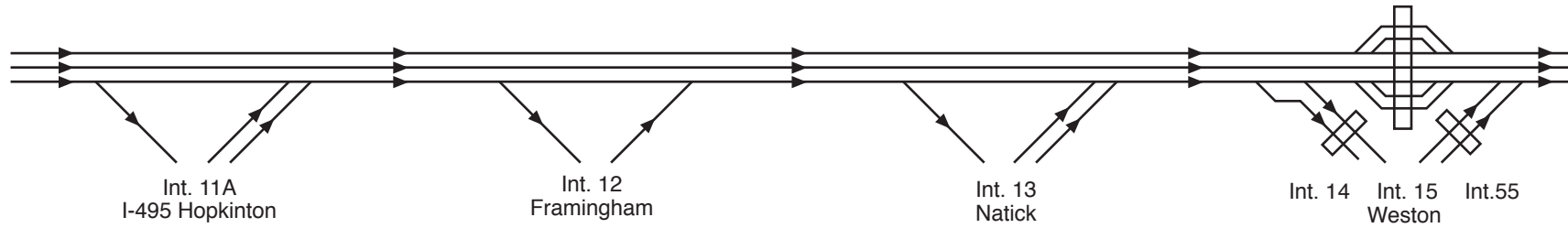

6-7 AM

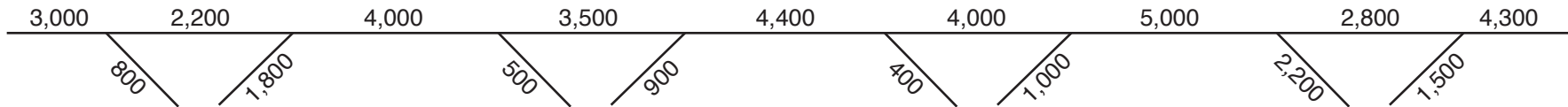

7-8 AM

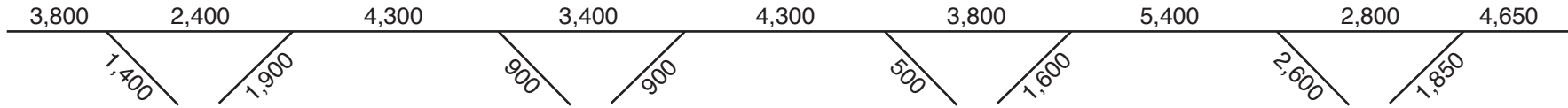

8-9 AM

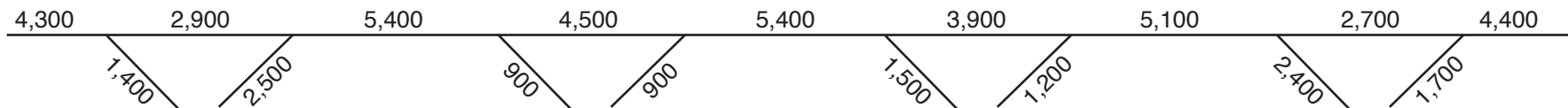

9-10 AM

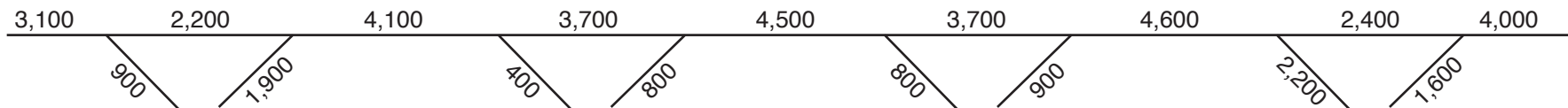

I-90/Mass Turnpike Eastbound: I-495, Hopkinton, to I-95/Route 128, Weston PM Peak Period Traffic Flow Diagrams: 2010

Route/Lane Schematic

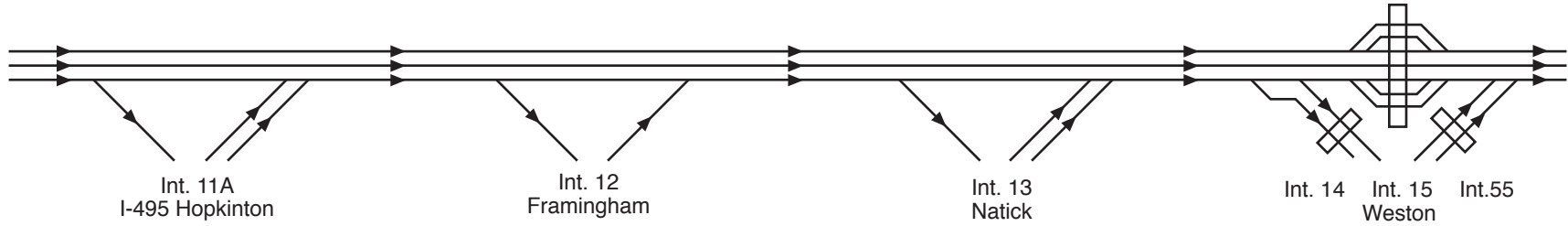

3-4 PM

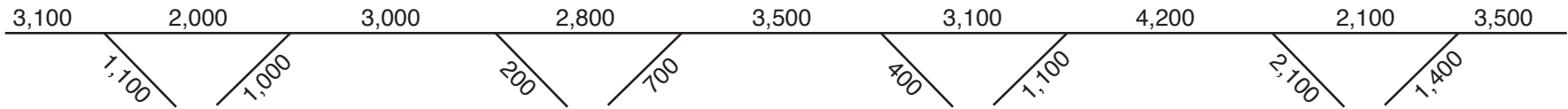

4-5 PM

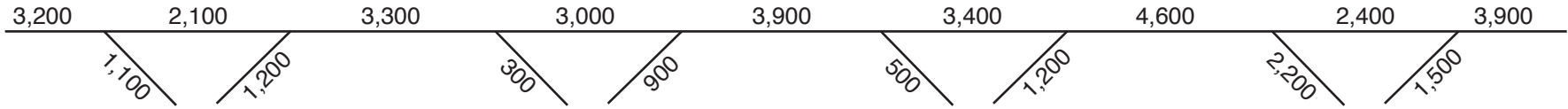

5-6 PM

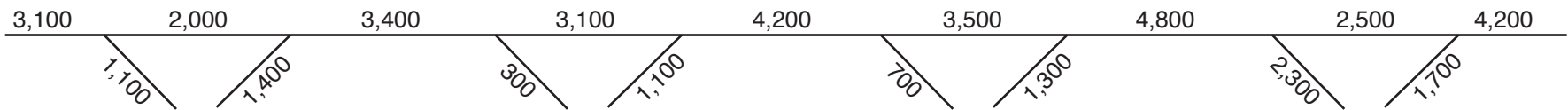

6-7 PM

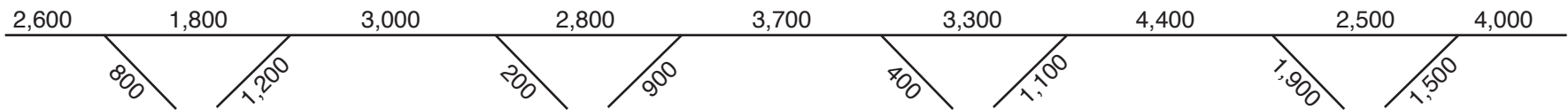

I-90/Mass Turnpike Westbound: I-95/Route 128, Weston, to I-495, Hopkinton AWDT Traffic Flow Diagrams: 1977, 1987, 1997, and 2010

Route/Lane Schematic

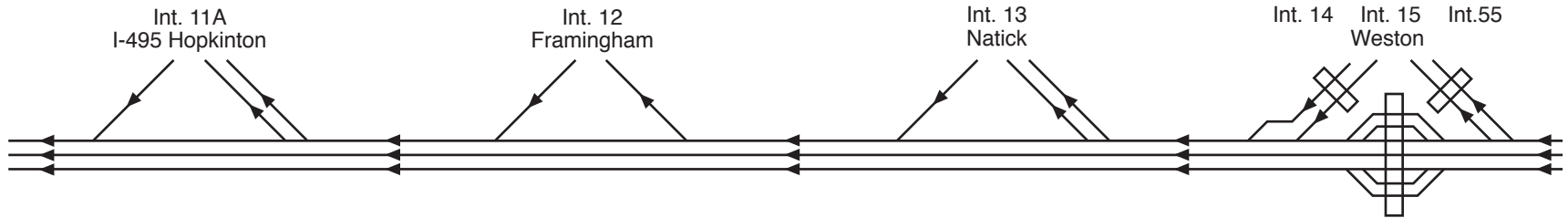

1977 AWDT

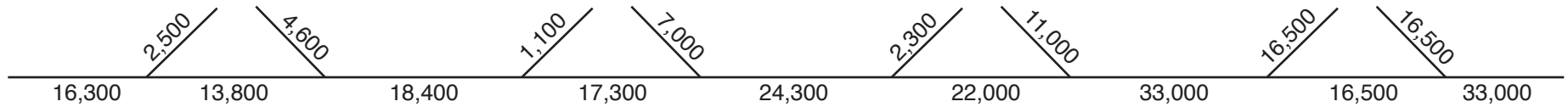

1987 AWDT

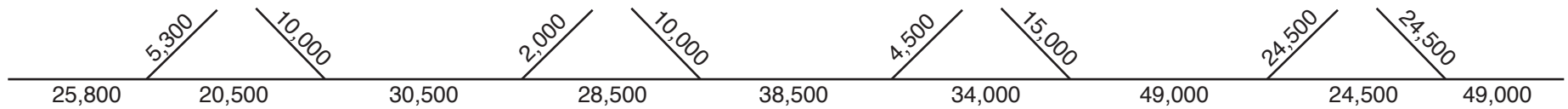

1997 AWDT

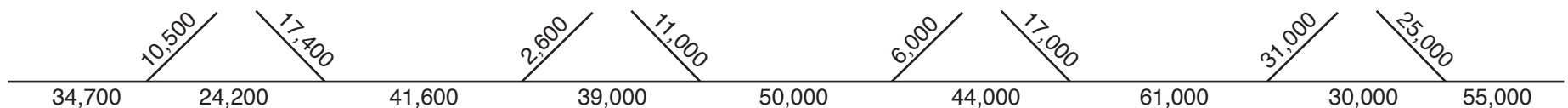

2010 AWDT

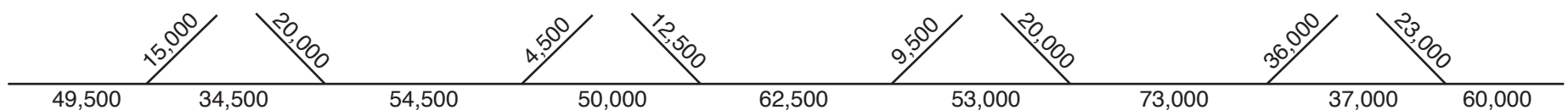

I-90/Mass Turnpike Westbound: I-95/Route 128, Weston, to I-495, Hopkinton AM Peak Period Traffic Flow Diagrams: 2010

Route/Lane Schematic

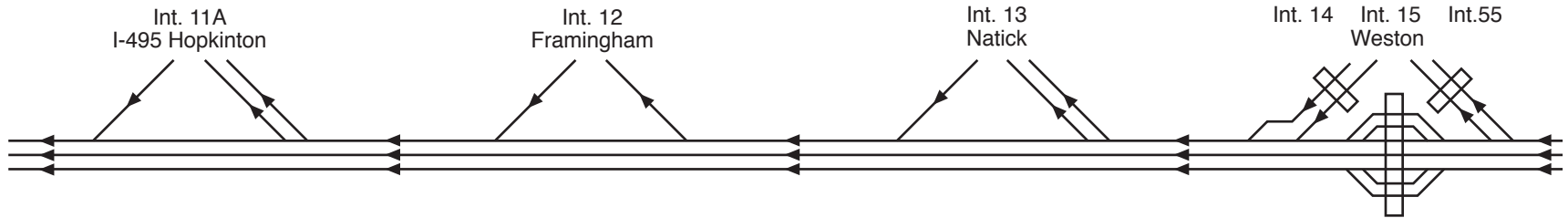

6-7 AM

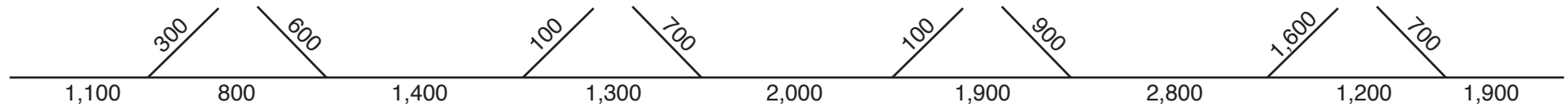

7-8 AM

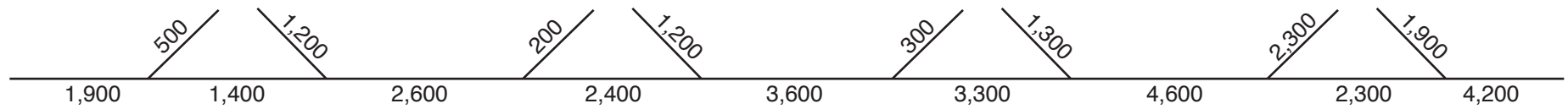

8-9 AM

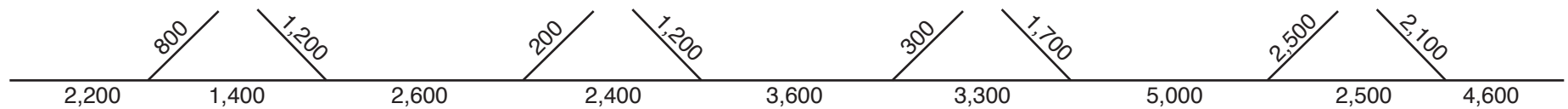

9-10 AM

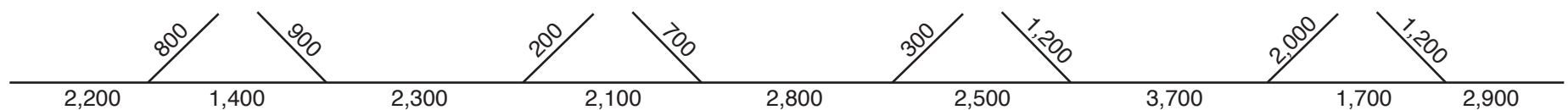

I-90/Mass Turnpike Westbound: I-95/Route 128, Weston, to I-495, Hopkinton PM Peak Period Traffic Flow Diagrams: 2010

Route/Lane Schematic

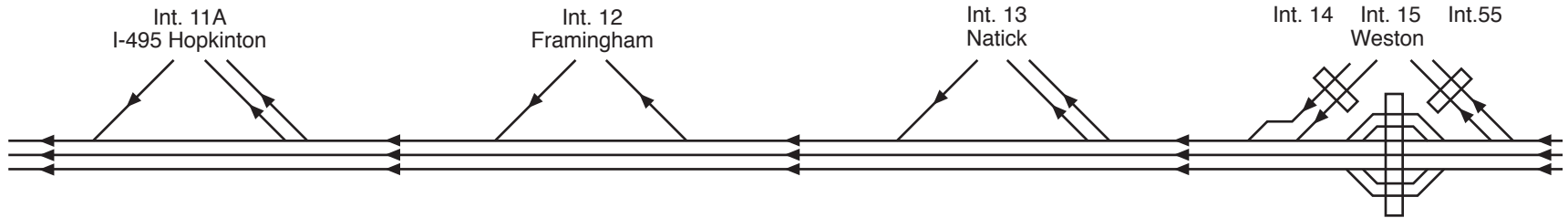

3-4 PM

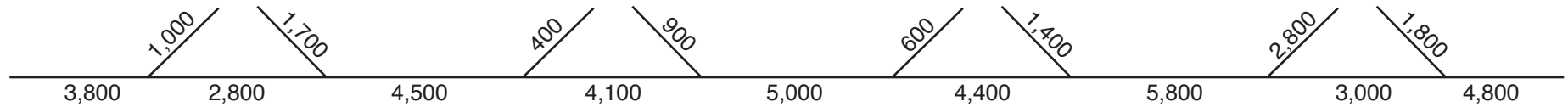

4-5 PM

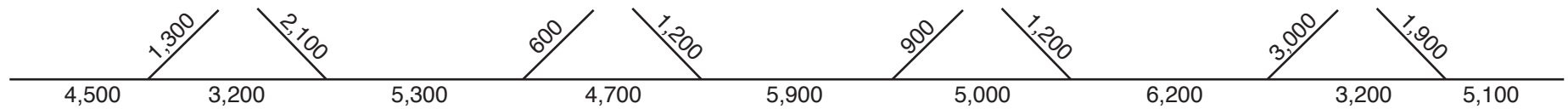

5-6 PM

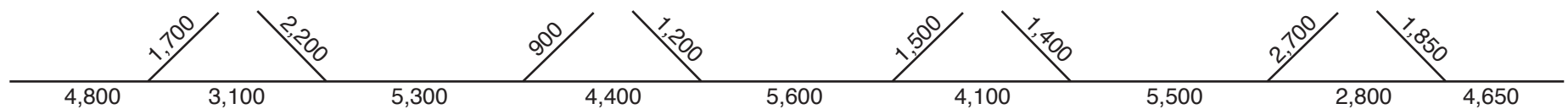

6-7 PM

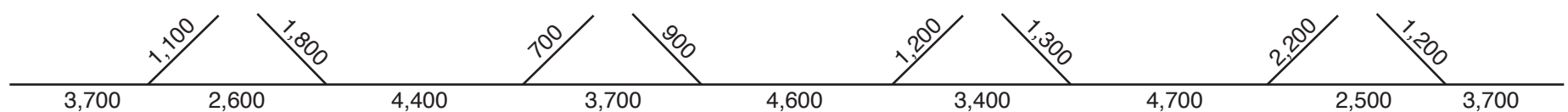

I-90 Mass Turnpike Extension Eastbound: East of I-95/Route 128, Weston, to West of I-93, Boston AWDT Traffic Flow Diagrams: 1977, 1987, 1997, and 2010

Route/Lane Schematic

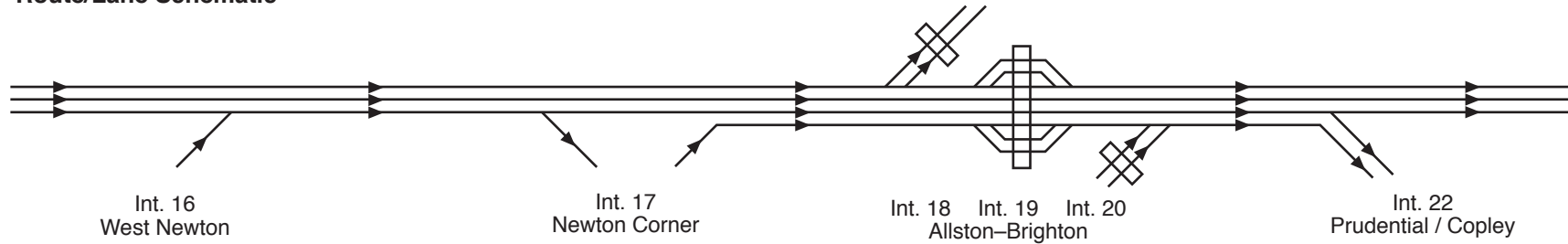

1977 AWDT

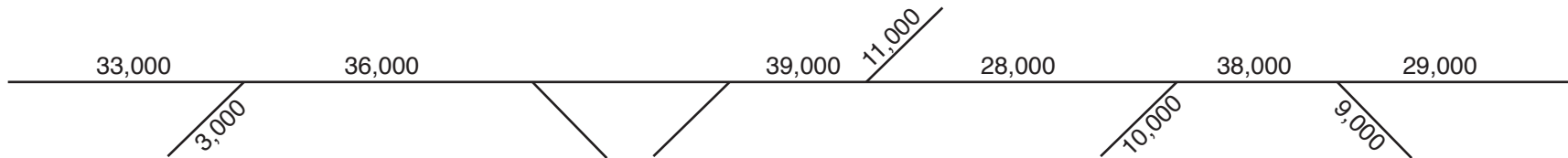

1987 AWDT

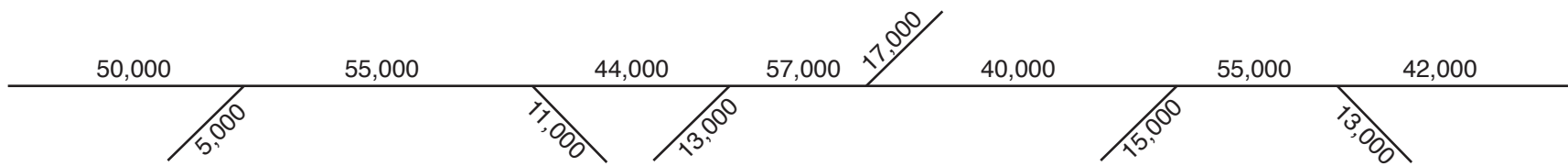

1997 AWDT

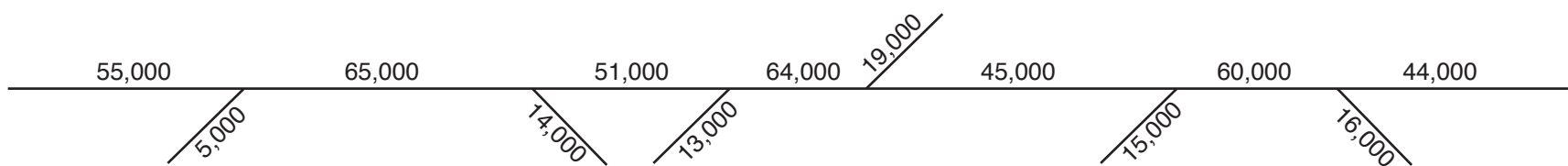

2010 AWDT

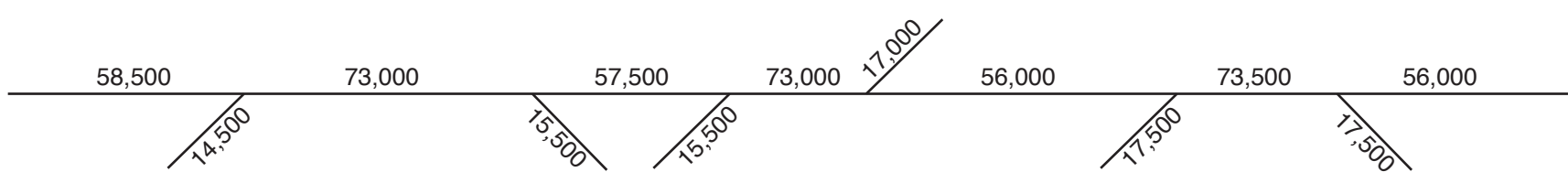

I-90 Mass Turnpike Extension Eastbound: East of I-95/Route 128, Weston, to West of I-93, Boston AM Peak Period Traffic Flow Diagrams: 2010

Route/Lane Schematic

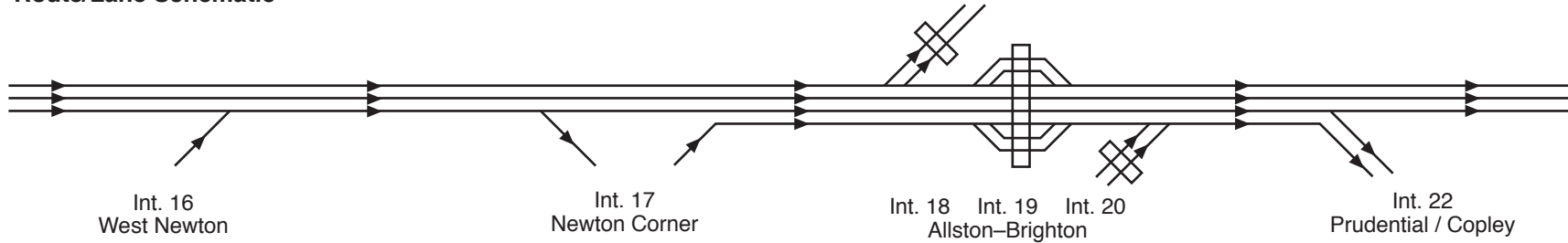

6-7 AM

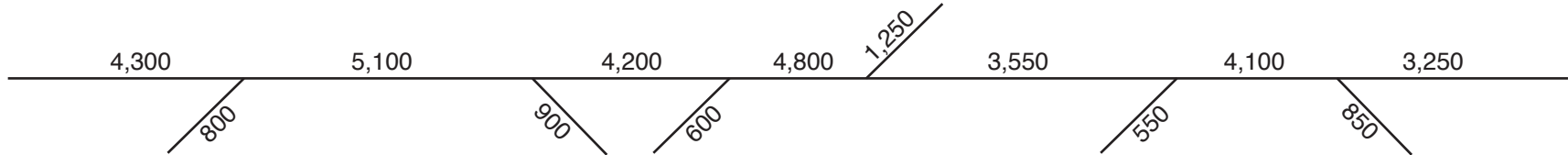

7-8 AM

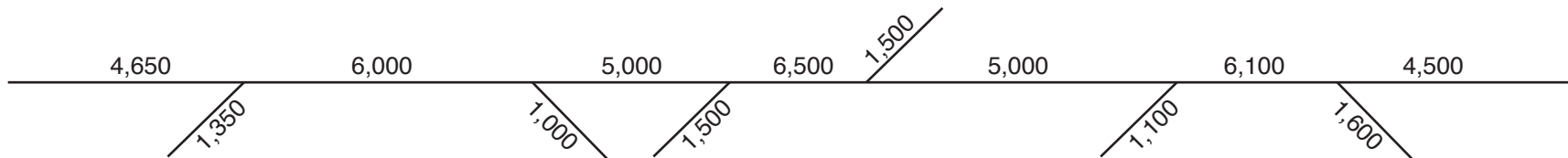

8-9 AM

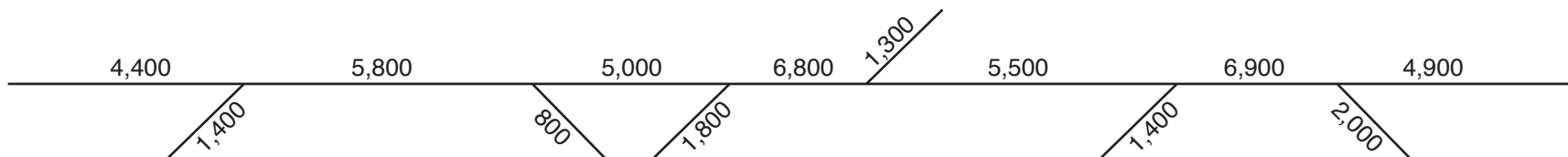

9-10 AM

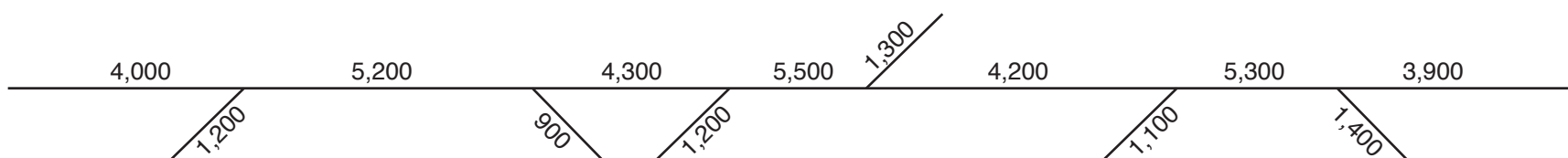

I-90 Mass Turnpike Extension Eastbound: East of I-95/Route 128, Weston, to West of I-93, Boston PM Peak Period Traffic Flow Diagrams: 2010

Route/Lane Schematic

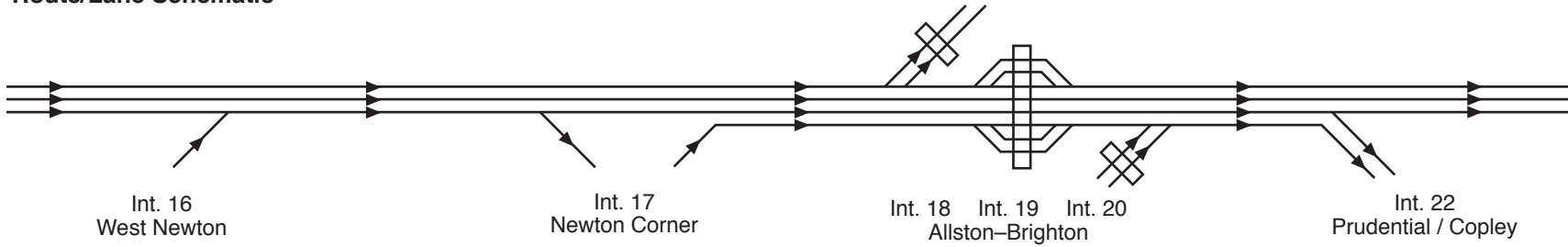

3-4 PM

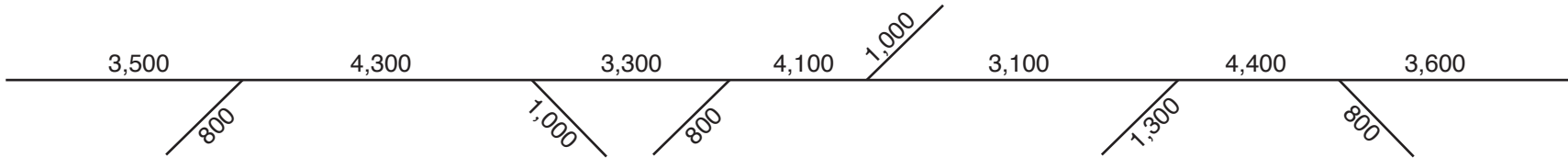

4-5 PM

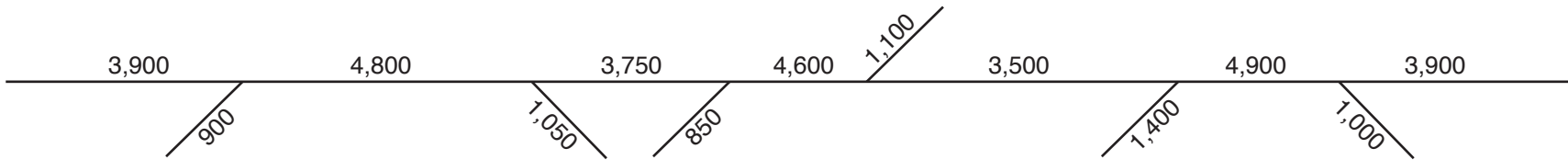

5-6 PM

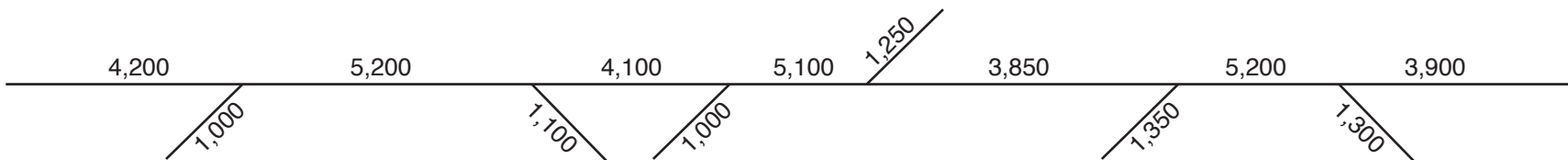

6-7 PM

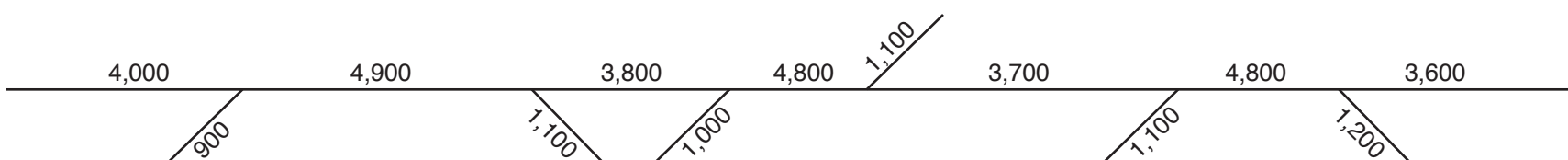

I-90 Mass Turnpike Extension Westbound: West of I-93, Boston, to East of I-95/Route 128, Weston AWDT Traffic Flow Diagrams: 1977, 1987, 1997, and 2010

Route/Lane Schematic

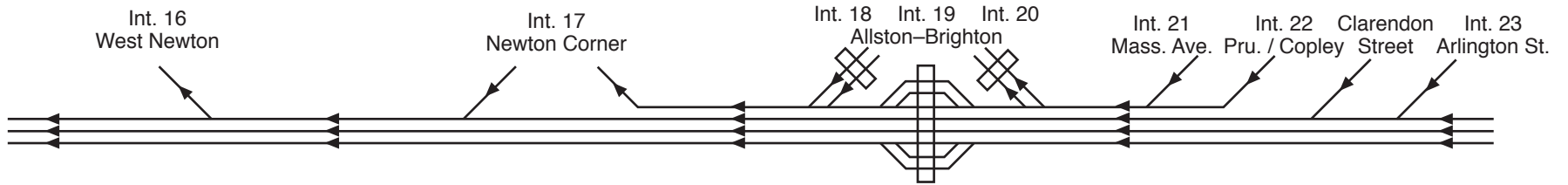

1977 AWDT

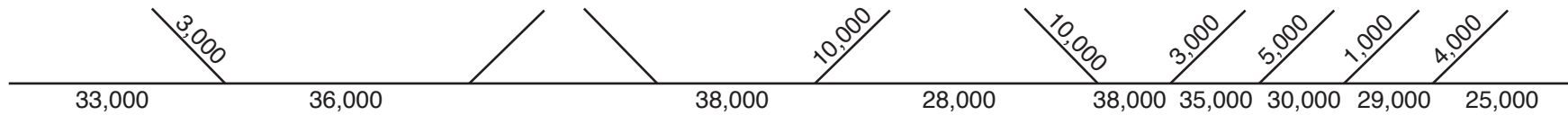

1987 AWDT

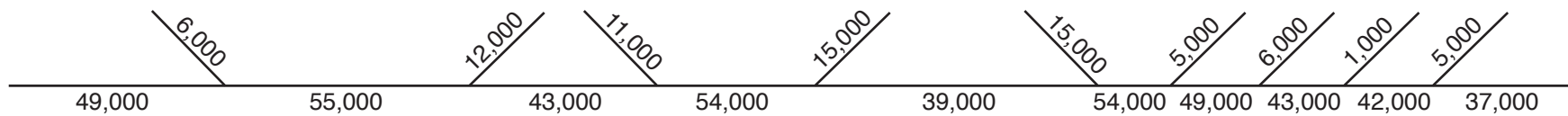

1997 AWDT

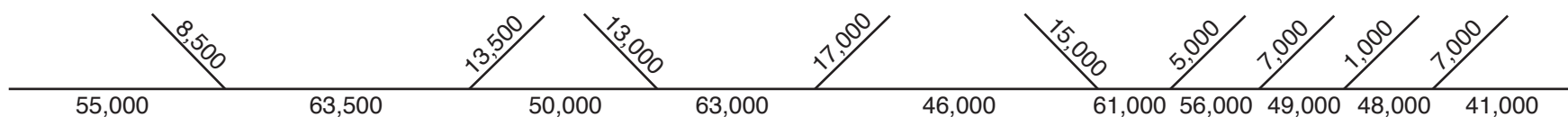

2010 AWDT

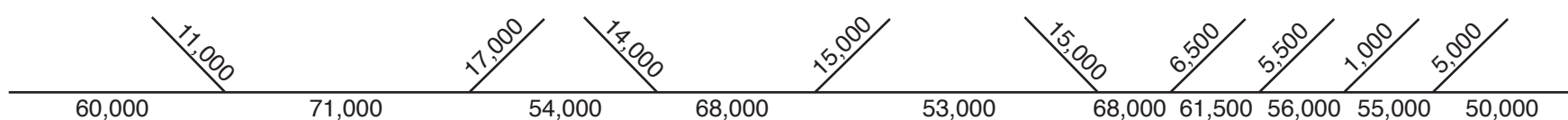

I-90 Mass Turnpike Extension Westbound: West of I-93, Boston, to East of I-95/Route 128, Weston AM Peak Period Traffic Flow Diagrams: 2010

Route/Lane Schematic

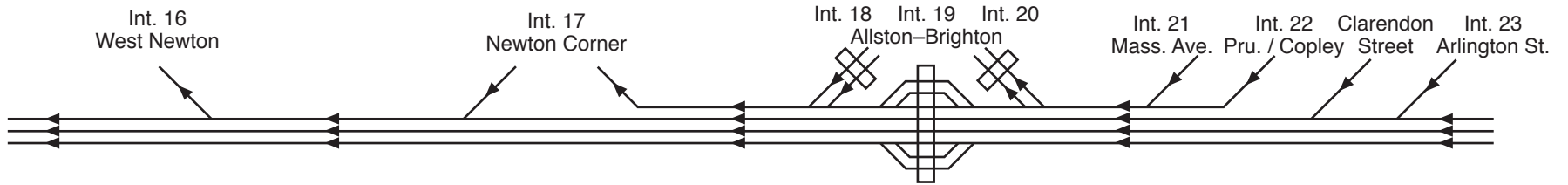

6-7 AM

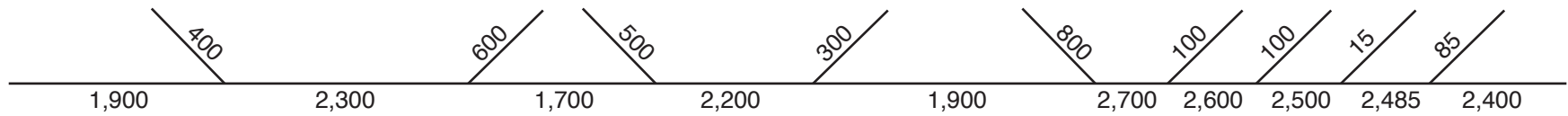

7-8 AM

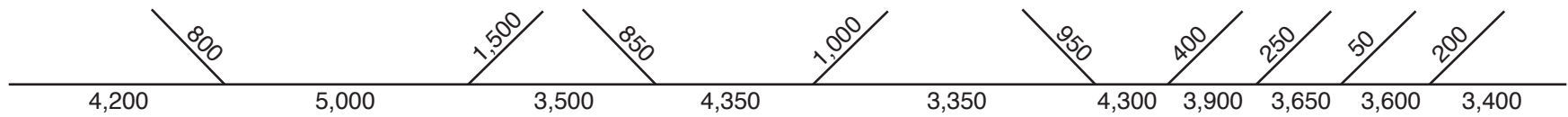

8-9 AM

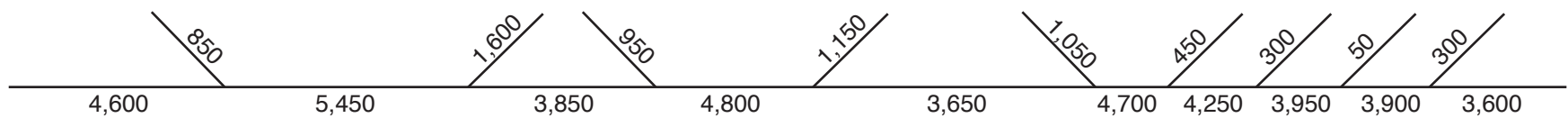

9-10 AM

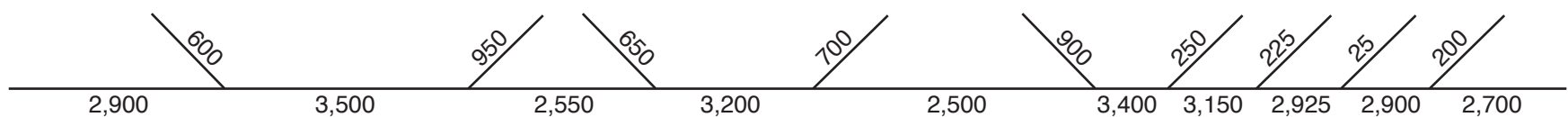

I-90 Mass Turnpike Extension Westbound: West of I-93, Boston, to East of I-95/Route 128, Weston PM Peak Period Traffic Flow Diagrams: 2010

Route/Lane Schematic

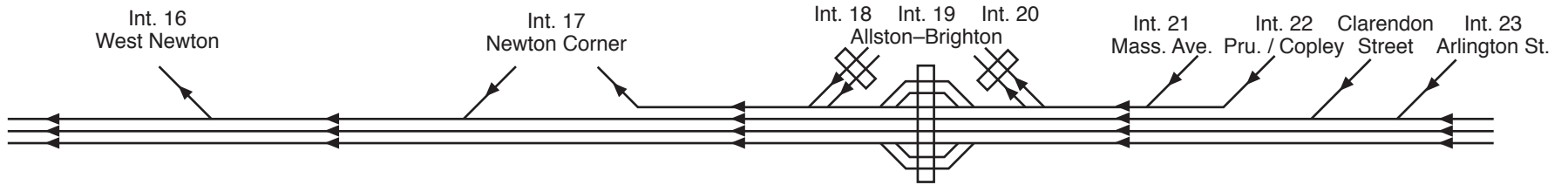

3-4 PM

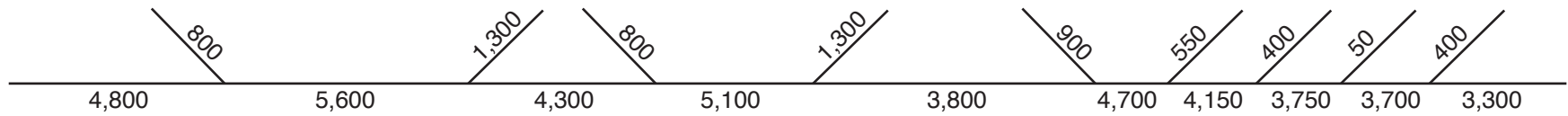

4-5 PM

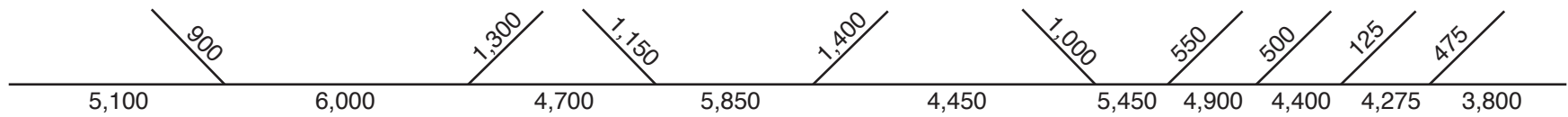

5-6 PM

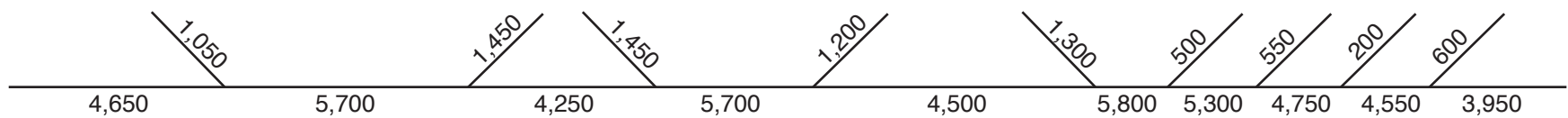

6-7 PM

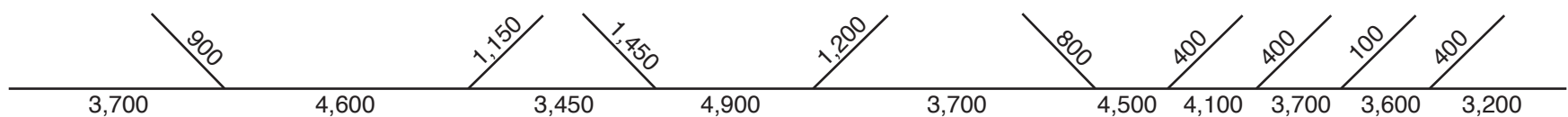

I-90 Eastbound: I-93, Boston, to Route 1A/Curtis Street, East Boston

AWDT Traffic Flow Diagrams: 2005 and 2010

Route/Lane Schematic

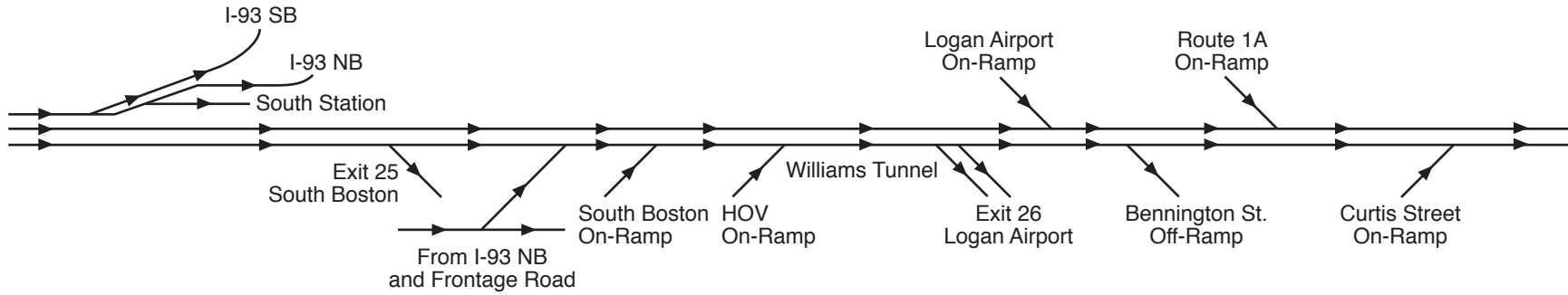

2005 AWDT

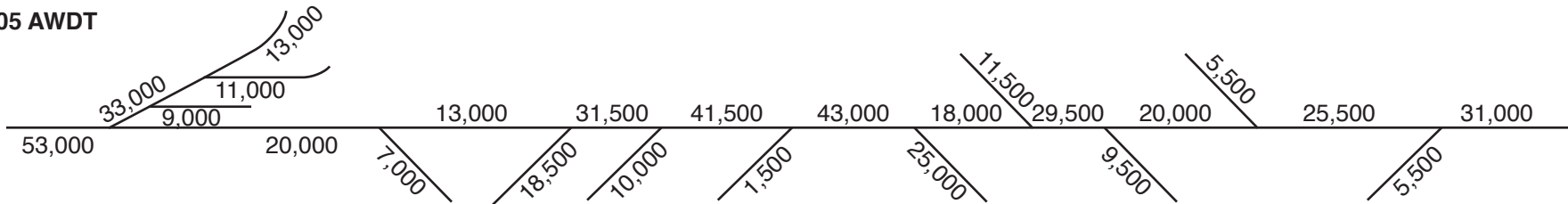

2010 AWDT

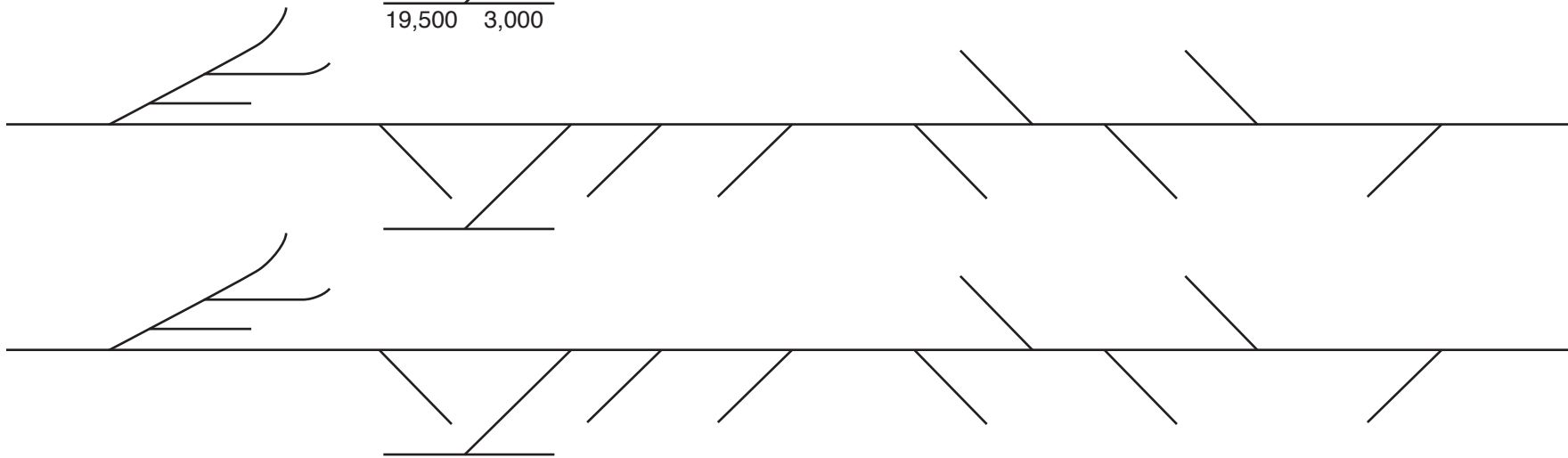
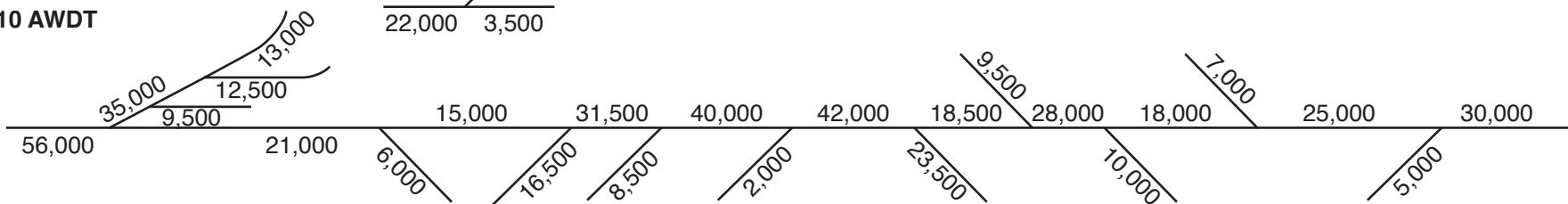

I-90 Eastbound: I-93, Boston, to Route 1A/Curtis Street, East Boston

PM Peak Period Traffic Flow Diagrams: 2010

Route/Lane Schematic

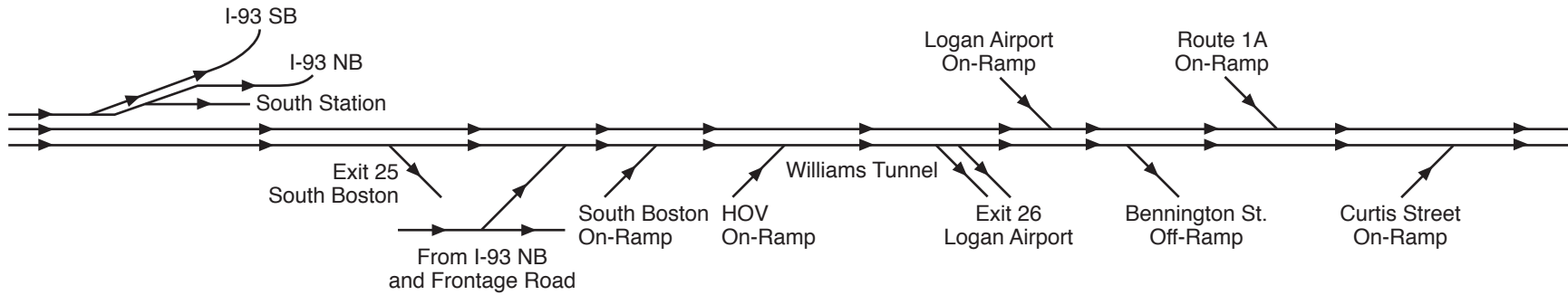

3-4 PM

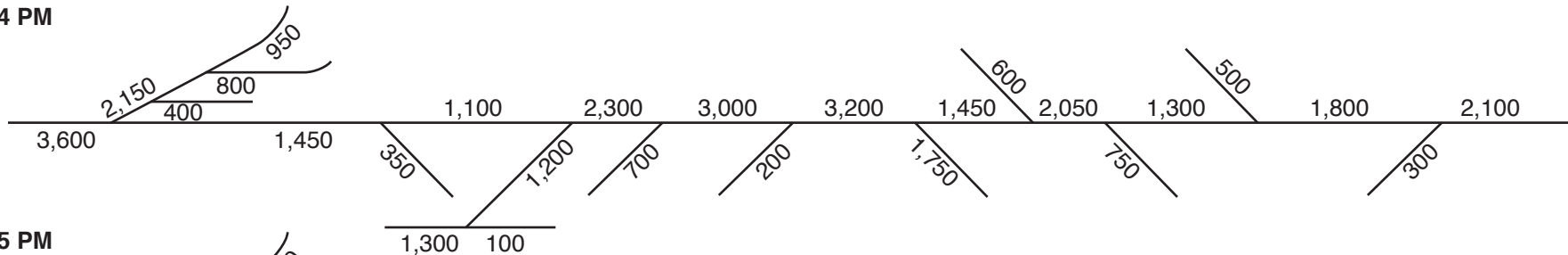

4-5 PM

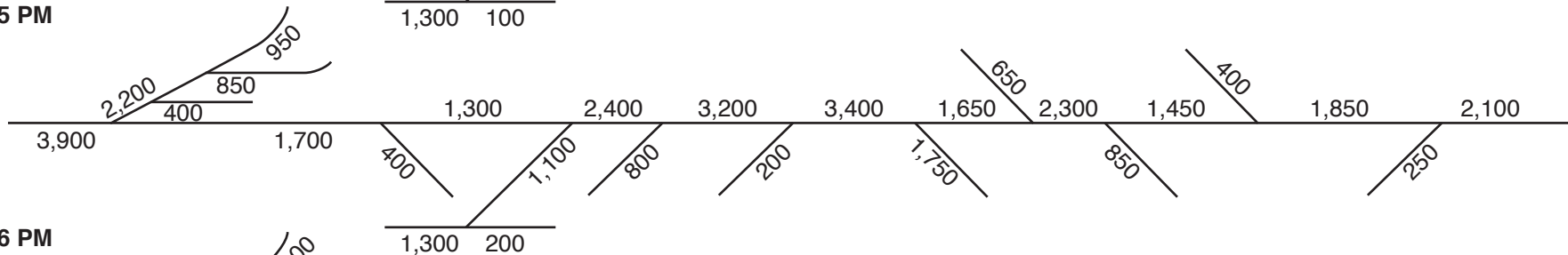

5-6 PM

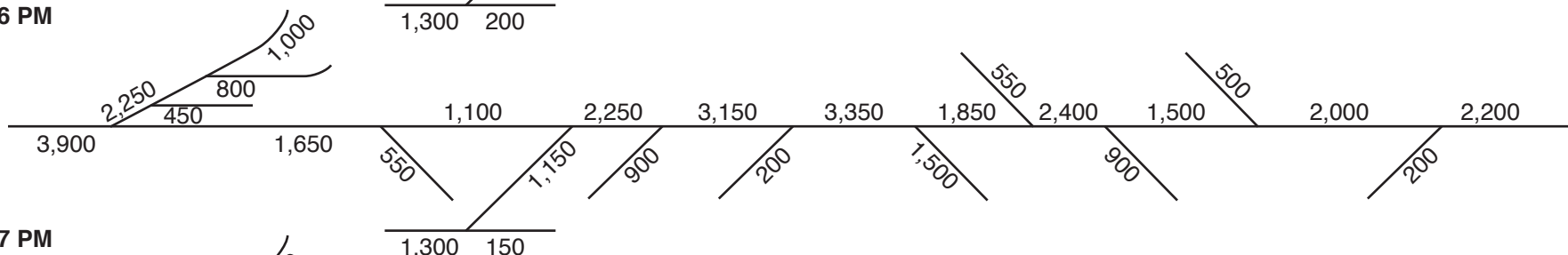

6-7 PM

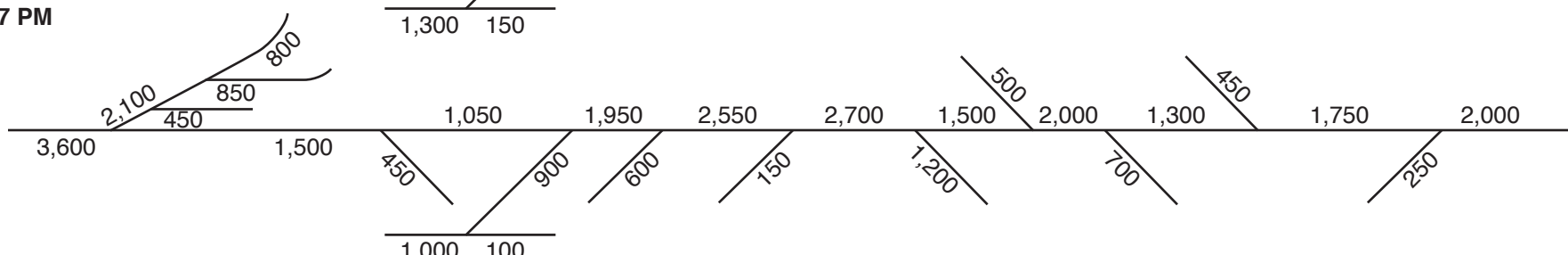

I-90 Westbound: Route 1A/Curtis Street to Central Artery AWDT Traffic Flow Diagrams: 2005 and 2010

Route/Lane Schematic

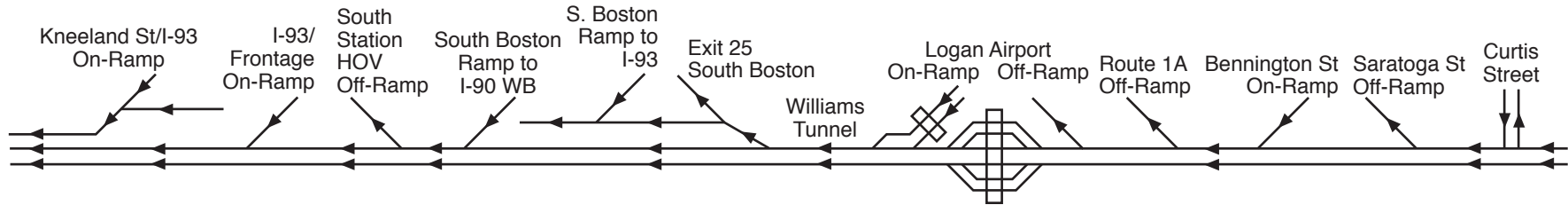

2005 AWDT

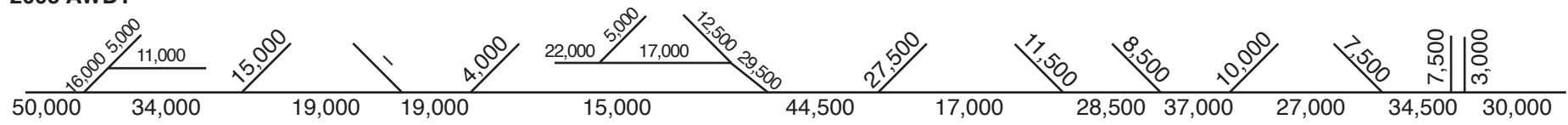

2010 AWDT

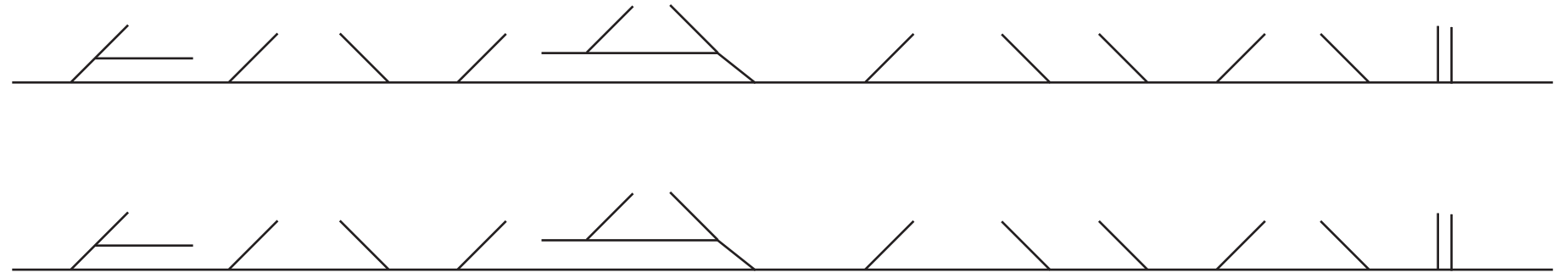
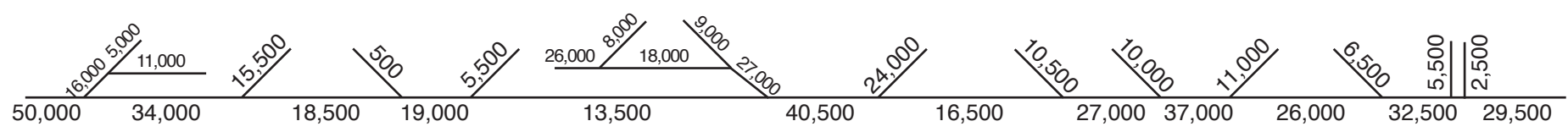

I-90 Westbound: Route 1A/Curtis Street to Central Artery AM Peak Period Traffic Flow Diagrams: 2010

Route/Lane Schematic

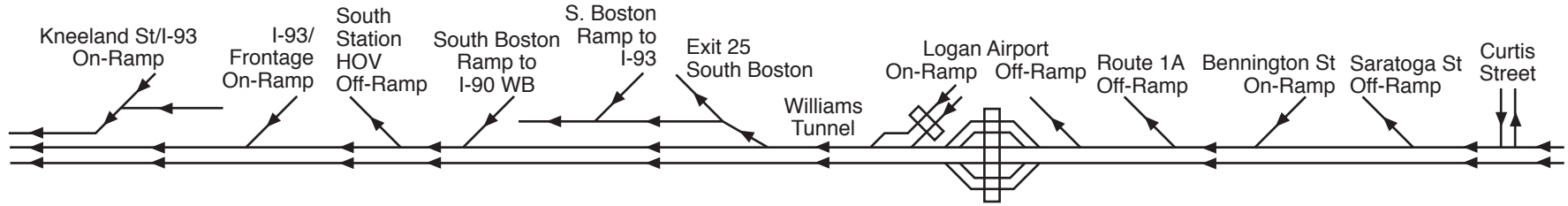

6-7 AM

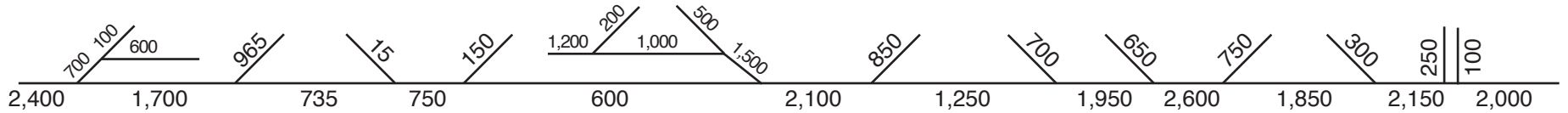

7-8 AM

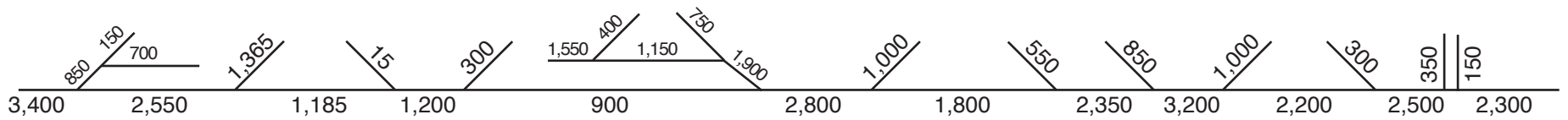

8-9 AM

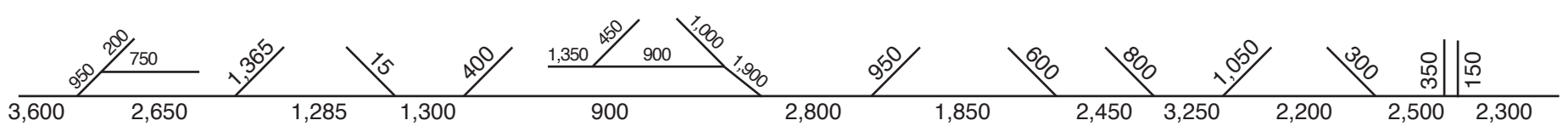

9-10 AM

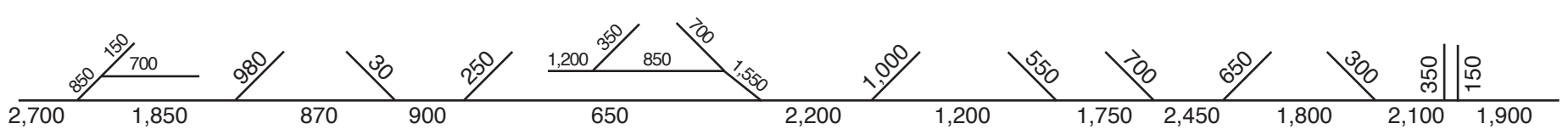

I-90 Westbound: Route 1A/Curtis Street to Central Artery PM Peak Period Traffic Flow Diagrams: 2010

Route/Lane Schematic

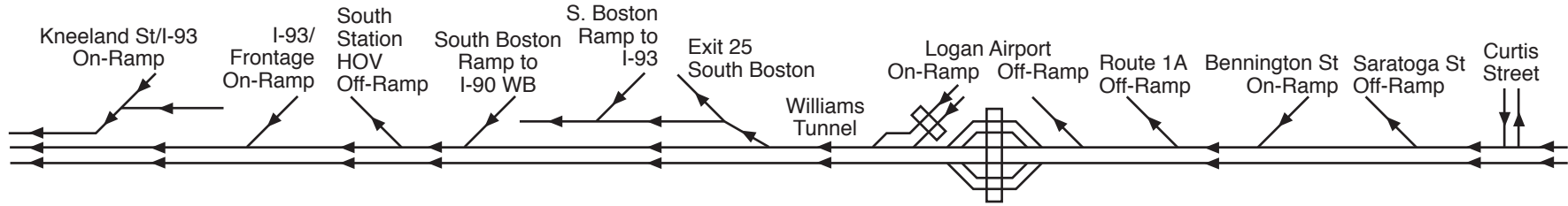

3-4 PM

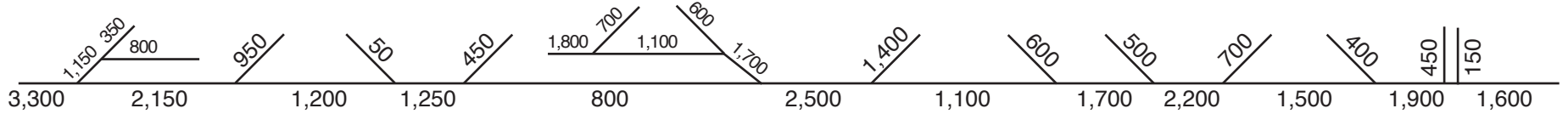

4-5 PM

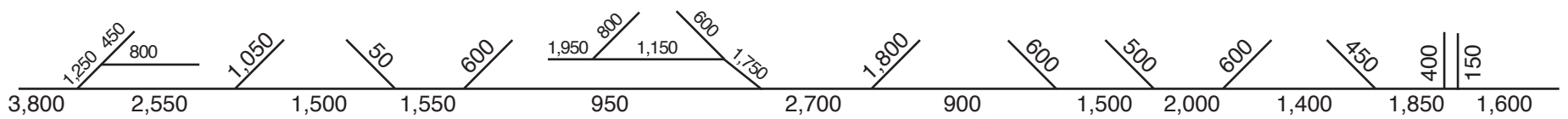

5-6 PM

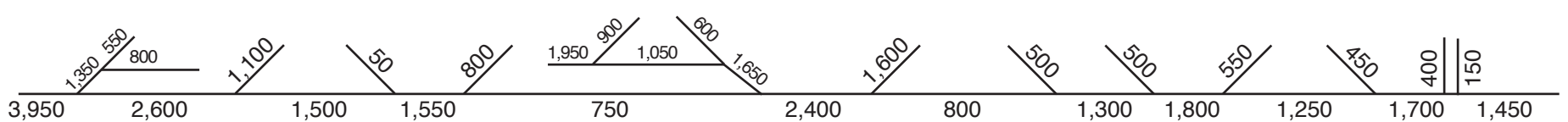

6-7 PM

